

OPIS TECHNICZNY

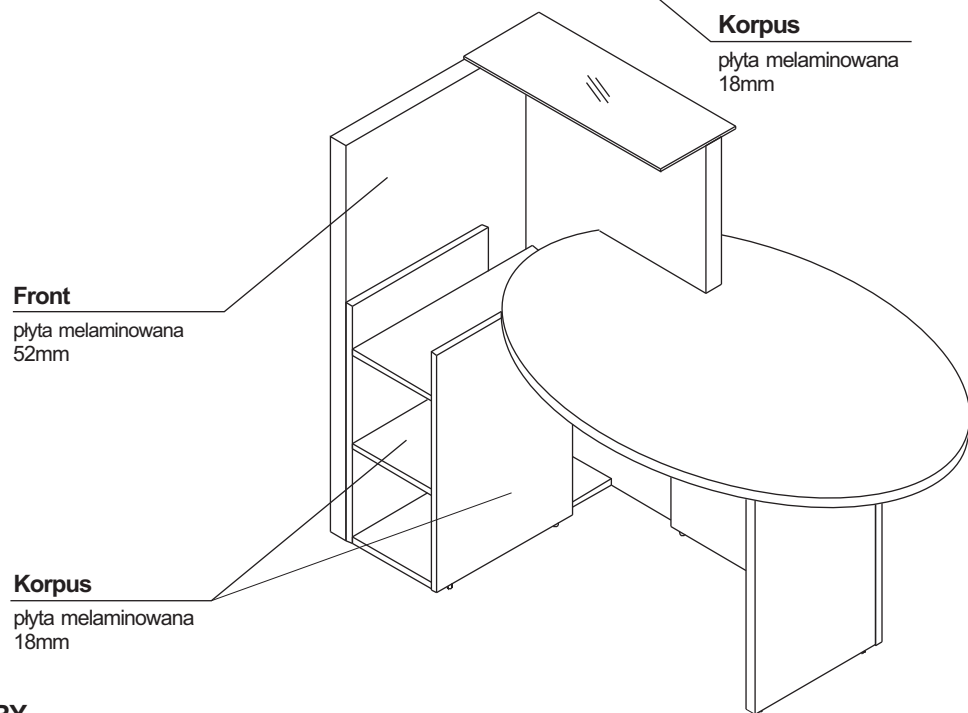

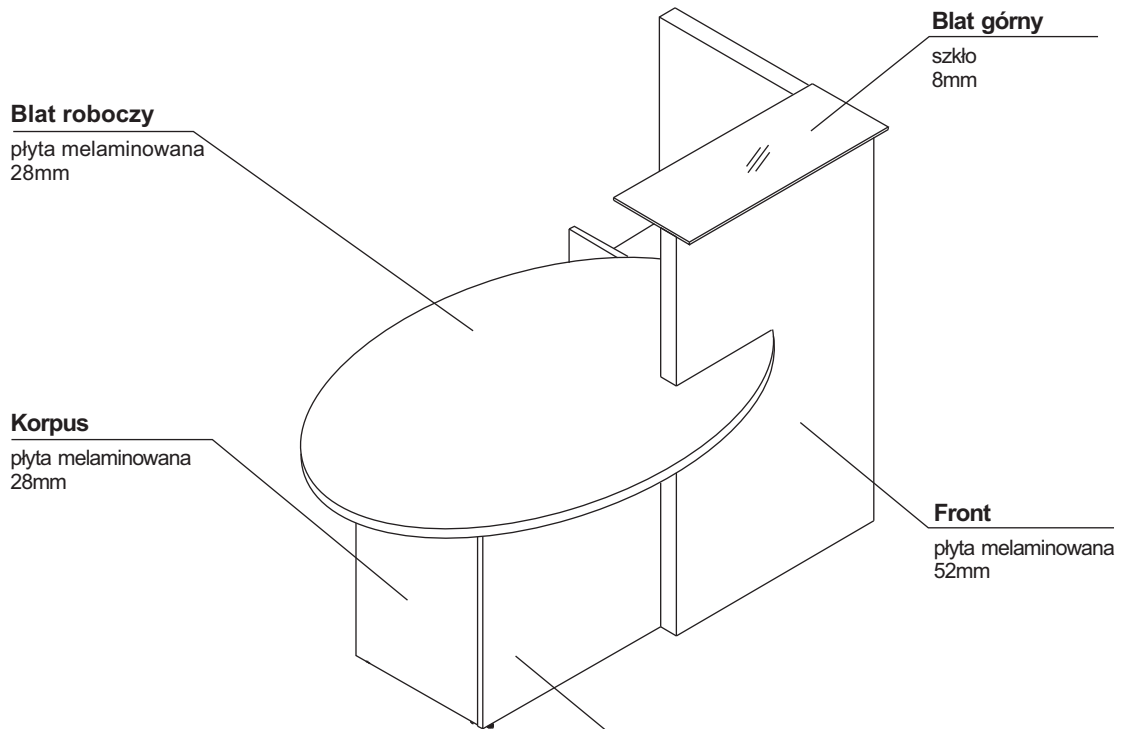

WYMIARY

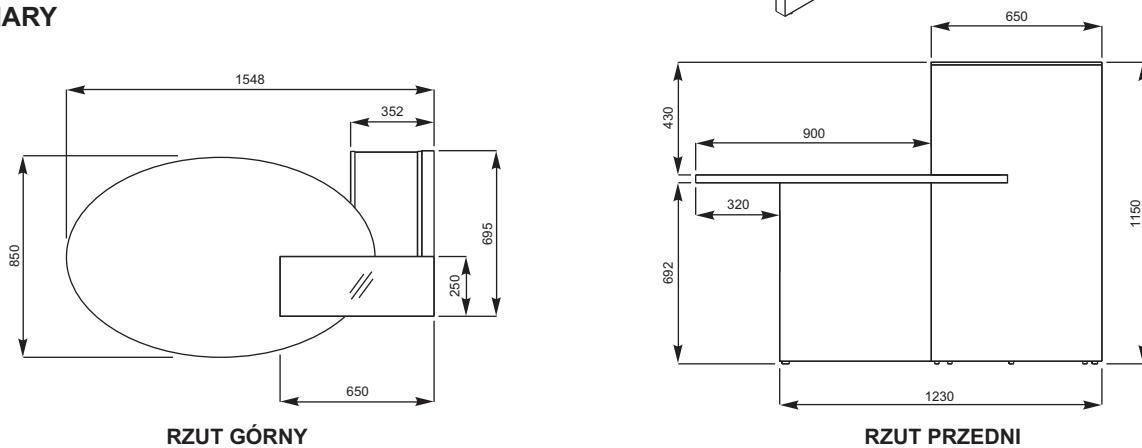



KOLORYSTYKA

| | |
|--|------------------------|
| BLAT GÓRNY  | SZKŁO SATYNOWANE |
| KORPUS, BLAT ROBOCZY  | 67-BIAŁY PASTEL |
| FRONT  | 34-KASZTAN 64-COCOA |

| WIDOK OBIEKTU | WYMIARY (mm) | | | SYMBOL |  |  |  | UWAGI |
|---------------|--------------|-----------|----------|--------|---|---|---|-------|
| | SZEROKOŚĆ | GLĘBOKOŚĆ | WYSOKOŚĆ | | kg | m ³ | szt | |

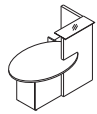
LADA OVO

| | | | | | | | | |
|---|------|-----|------|--------------|------|------|---|--|
|  | 1550 | 870 | 1150 | LOP10 | 85,6 | 0,24 | 3 | |
|  | 1550 | 870 | 1150 | LOL10 | 85,6 | 0,24 | 3 | |

LEGENDA:

 - WAGA NETTO

 - OBJĘTOŚĆ

 - ILOŚĆ PACZEK